

# BARADINE

2026

A cyclist is riding on a paved road that curves through a lush, green mountainous landscape. The road is flanked by dense vegetation and trees. In the background, there are rolling hills and mountains under a clear sky. The overall scene is bright and scenic, suggesting a sense of adventure and outdoor activity.

SECURITY · RELIABILITY · DURABILITY · ORIGINALITY

# INTRODUCTION

---

Since its foundation, Baradine has been renowned as market leader for cycle braking products. This reputation is strengthened by its technical expertise and thirty years experience. A commitment to research, development, testing and manufacture and above a passion for cycling ensures that Baradine leads where others can only follow.

Baradine products are manufactured to exacting standards using scientifically developed compounds and designs for each and every type of braking system. This is achieved by taking account of specific operational requirements and environmental conditions. So whether you're taking a leisurely Sunday morning ride, competing in the Tour de France or taking on the best in the downhill championships, you can be confident that your brakes will meet and exceed your expectations.

The Baradine logo on your braking products is your guarantee of performance, reliability, durability and quality; don't settle for second best.

The Baradine logo consists of the word "BARADINE" in a bold, uppercase, sans-serif font. The letters are white with a thin black outline. The letters are slightly shadowed, giving them a three-dimensional appearance as if they are floating above a surface. The background behind the text is a dark, textured orange.

# S T R E T N O C

ROTOR 01

ADAPTOR 03

DISC PADS 06

EXTRA LIGHT 13

V-TYPE 14

ROAD 16

CANTILEVER 20

ABS TECH / BMX 21

COOLING SOLUTION 22

HYDRAULIC HOSE 25

ASCESSORIES 26

INNER WIRE 27

OUTER CASING 28



Size : 140 /160 /180mm

Size	Weight
140mm	131.8g
160mm	155.2g
180mm	186.5g
203mm	223.6g



Size : 203mm

### DB-09CL

- 2-piece Center Lock type
- SUS410 braking band
- Thickness : 1.8 ± 0.1mm
- Double grounded
- Rustproof treatment
- Brake wear indicator

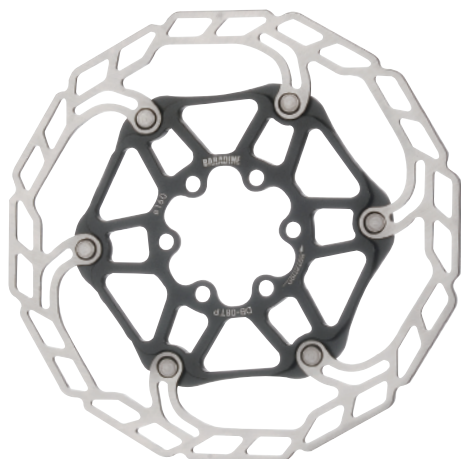

### DB-08TP

- Outer Disc : SUS410
- Inner Disc : 7075-T6
- Excellent heat dissipation
- 2-piece

Size	Weight
160mm	100.5g
180mm	123.5g

Color	Red	Black

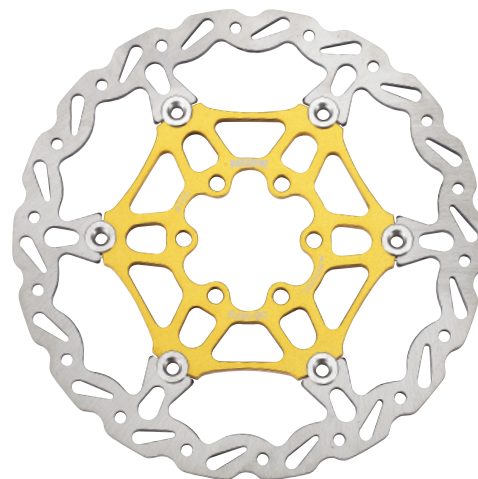

### DB-06FB Floating

- Outer Disc : SUS410
- Inner Disc : 7075-T6
- Excellent heat dissipation

Size	Weight
160mm	111.5g
180mm	138.5g

Color	Red	Black	Blue	Gold	Silver

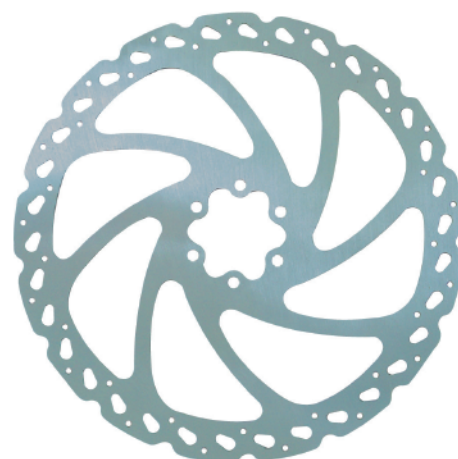

### DB-01

- Stainless steel 410
- Superior heat dissipation
- Excellent disc wear

Size	Weight
160mm	115.5g
180mm	135.5g
203mm	194.5g

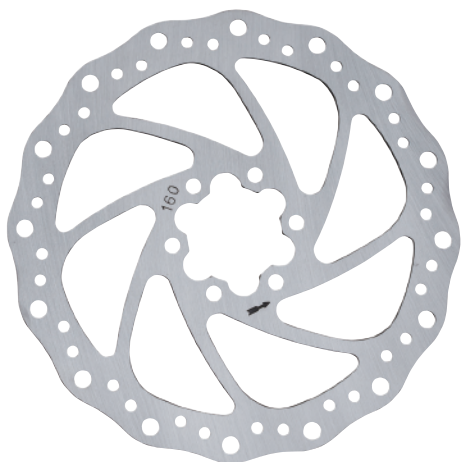

### DB-02

- Stainless steel 410
- Superior heat dissipation
- Excellent disc wear

Size	Weight
140mm	94g
160mm	140g
180mm	173.5g
203mm	200.5g

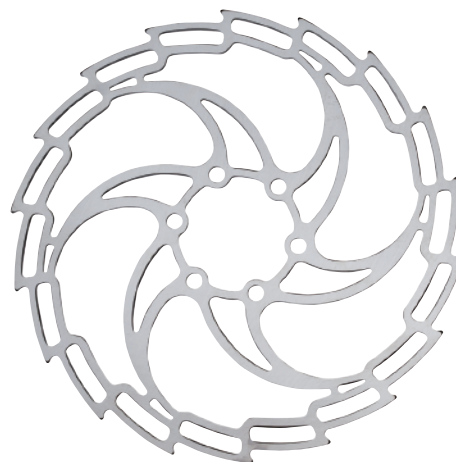

### DB-05

- Stainless steel 410
- Superior heat dissipation
- Excellent disc wear

Size	Weight
160mm	83.5g
180mm	111.5g
203mm	143g

### DB-05D

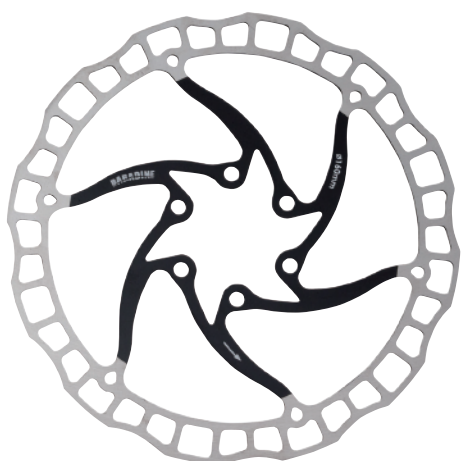

### DB-07

- Stainless steel 410
- Superior heat dissipation
- Excellent disc wear

Size	Weight
140mm	68g
160mm	85g
180mm	106.5g
203mm	131g

### DB-07D

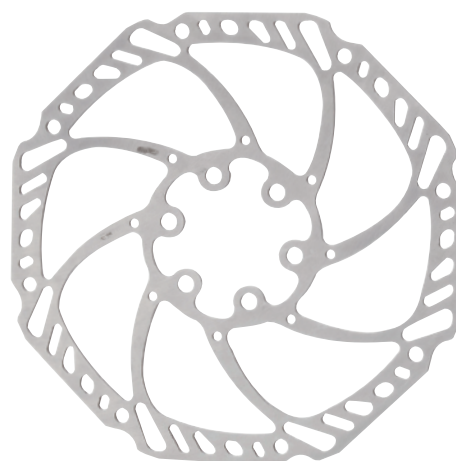

### DB-10

- Stainless steel 410
- Superior heat dissipation
- Excellent disc wear

Size	Weight
160mm	91g
180mm	116g
203mm	127g



PM-IS-F160



PM-IS-R160  
PM-IS-F180



PM-IS-R180  
PM-IS-F203



PM-IS-R203



PM160-PM180



PM160-PM203



PM180-PM203



PM180-PM220

## POST MOUNT

ROTOR	φ 140	φ 160	φ 180	φ 203	φ 220
<b>FORK</b>					
IS		PM-IS-F160	PM-IS-F180	PM-IS-F203	
PM 160		DIRECT	PM160-PM180	PM160-PM203	
PM 180			DIRECT		PM180-PM220
PM 203				DIRECT	PM180-PM203
PM 220					DIRECT
<b>FRAME</b>					
IS	PM-IS-F160	PM-IS-R160	PM-IS-R180	PM-IS-R203	
PM 160		DIRECT	PM160-PM180	PM160-PM203	
PM 180			DIRECT	PM180-PM203	PM180-PM220
PM 203				DIRECT	



PM-FM-R140



PM-FM-R160



PM-FM-F140



PM-FM-F160



FM-FM-F140-160  
FM-FM-F160-180



FM-FM-R160  
FM-FM-R180

## FLAT MOUNT

ROTOR	Φ 140	Φ 160	Φ 180
<b>FORK</b>			
FM (140 / 160)	FM-FM-F140-160	FM-FM-F140-160	
FM (160 / 180)		FM-FM-F160-180	FM-FM-F160-180
<b>FRAME</b>			
FM (140 / 160)	DIRECT	FM-FM-R160	
FM (160 / 180)		DIRECT	FM-FM-R160

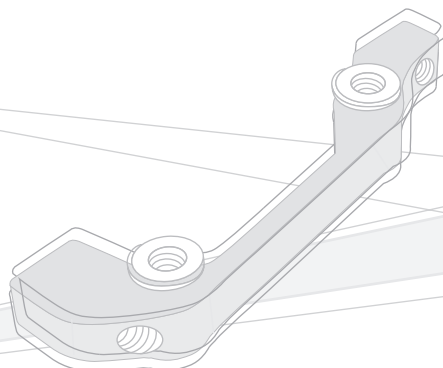

	BOOST FORK 110 x15mm	BOOST Frame 148 x 12mm
MTB FORK 100 x15mm	BC-05 (5mm)	X
MTB FRAME 142 x12mm	X	BC-04 (3mm)
<p>Aluminum 6061-T6 Material 1 set = 1 Hub Adapter, 2 Spacers, 6 Screws</p>		

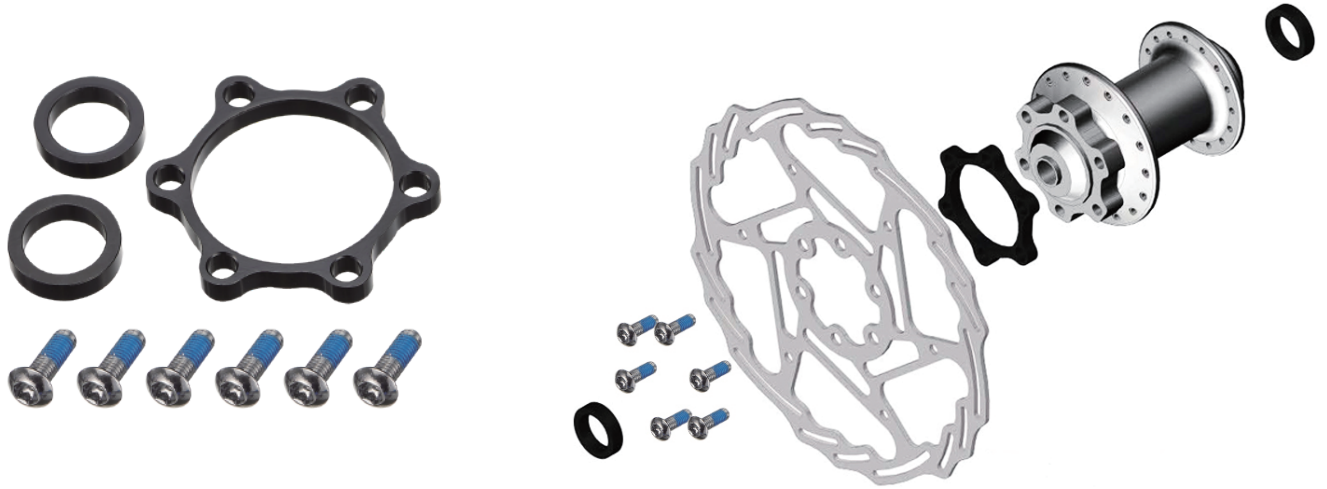

**FEATURE**

- 1.Precision broached spline
- 2.CNC aluminum shoulder pins
- 3.Steel carrier plate
- 4.CNC aluminium lock ring
- 5.Torque 40Nm

**ADVANTAGES**

- Min black-lash
- Extremely light weight
- Improved strength

**CENTER LOCK**

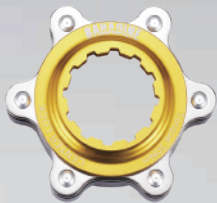

**BC02**  
Fit 9/10/12mm Axle



**BC03**  
Fit 9/10/12/15/20mm Axle





Sintered compound is designed to produce consistent performance in all condition, offer high durability and high resistance to contamination by mud, water, sand and grit.



Organic compound is softer than other compounds, it's gentle to your disc with superior performance, great initial bite feel and quiet, perfect for dry condition.



Semi compound is specially formulated to produce excellent all around performance, perfect for everyday use.

\* The appearance of backing plates may have minor difference due to different compound applied.

## SHIMANO

Shimano XT BR-M755 , Grimeca system8 ,  
Sram Mechanical 9.0 , Hope Mono M4/  
Tech M4 / The cleg / Stealth Race E4  
Tech4 E4 , Trickstuff the cleg 4

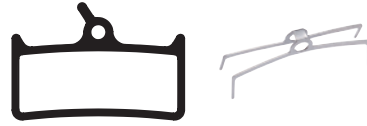

- DS-09+SP-09
- DS-09R+SP-09
- DS-09S+SP-09

Shimano Deore(BR- M375 / M395 / M415 / M416 / M445  
M446 / M447 / M465 / M475 / M485 / M486 / M495 / M515  
M515LA / M525 / M575 / T615), Nexave (BR-C501 / C601)  
LX BR-T675 / RST D-Power Mech, Tektro Aquila MD-M500  
Auriga(HD-M290 / M291 / T525 / T530 / E525 / E530 / E500)  
Draco2 HD-M352, Orion( SL HD-M740 / HD-M730 / HD-M725)  
Gemini(SL HD-M520 / M521 , HD-M500 / M501 / HD-M510)  
HDC330 HD-M330, MD-M280, Aries MD-M300, Mira MD-C400  
Volans HD-T710, Vela HD-T290, Dorado HD-E715 / TRP Hylex  
HY, Spyre SLC Spyre, Spyke, Dash Sport, Giant MPH Root

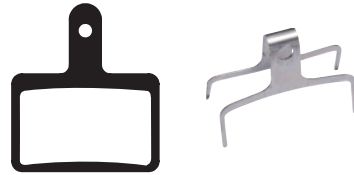

- DS-10+SP-10
- DS-10R+SP-10
- DS-10S+SP-10

Shimano Deore , Naxave BR-M555 Hydraulic



- DS-15+SP-15
- DS-15R+SP-15
- DS-15S+SP-15

Shimano XTR(BR-M965 / M966 / M975 / M975P),  
Saint BR-M800, Hone BR-M601, SLX BR-M665, Deore XT  
(BR-M765 / M775 / M776), Deore LX(BR-M585/T605/T665)  
Deore(BR-M535 / M595 / M596), Alfine(BR-S500 / S501)  
BR-M545, BR-R505, BR-T605 / TRP Dash carbon, Parabox



- DS-17+SP-17
- DS-17R+SP-17
- DS-17S+SP-17

Shimano XTR BR-M9120, XT BR-M8020  
Saint (M810 / M820), Zee M640, BR-MT520  
TRP Quadiem, Quadiem SL, Slate T4  
Tektro HD(M735 / M745 / 755), HD(E720 / E725)



- DS-43+SP-43
- DS-43R+SP-43
- DS-43S+SP-43

Shimano XTR (BR-M9000 / M9020 / M987 / M988 / M985)  
XT (BR-M8000 / M785), SLX (BR-M7000 / M675 / M666)  
DEORE BR-(M6000 / M615), ALFINE BR-S700, BR-(RS785 / R785  
CX75 / R515 / R315), FSA K-Force, DB-TX-9000, Afterburner  
DB-TX-9150 / REVER MCX1 Post Mount



- DS-52+SP-52
- DS-52R+SP-52
- DS-52S+SP-52

Shimano Dura Ace BR-R9170,Ultegra BR-R8070  
XTR BR-M9100,BR-(RS305 / RS405 / RS505 / RS805)  
Tektro HD-R310, REVER MCX1 Flat Mount



- DS-63+SP-63
- DS-63R+SP-63
- DS-63S+SP-63

























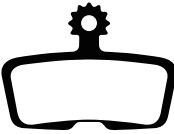











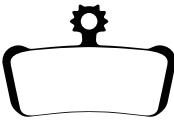

## AVID/SRAM

Avid Juicy(Carbon / 3 / 5 / 7 / ultimate)  
BB7 mechanical, Promax DSK-950

















- DS-11+SP-11
- DS-11R+SP-11
- DS-11S+SP-11

































# AVID/SRAM

Avid Code(2007-2010), Code(5 / 7)			 DS-34+SP-34  DS-34R+SP-34  DS-34S+SP-34
Avid BB5 mechanical, Promax(DC-710 / 720 / 913 ), (DSK-300 / 300R / 310 / 330R / 717 / 717R), Render, Render R			 DS-38+SP-38  DS-38R+SP-38  DS-38S+SP-38
Avid Elixir (1 / 3 / 5 / VIA GT / 7 / 9 / R / CR) SRAM XX, X0, DB (5 / 3 / 1) , Level TL, T, Level			 DS-44+SP-44  DS-44R+SP-44  DS-44S+SP-44
Sram Code 2011-2017 / R / RSC, Guide RE			 DS-54+SP-54  DS-54R+SP-54  DS-54S+SP-54
Avid DB (1 / 3 / 5)			 DS-55+SP-44  DS-54R+SP-44
Avid road RED / SRAM HRD eTap HRD Level Ultimate, TLM			 DS-56+SP-56  DS-56R+SP-56  DS-56S+SP-56
Avid XO Trail, Elixir (7 Trail / 9 Trail) Sram Guide (ultimate / RSC / RS / R / T / G2			 DS-57+SP-57  DS-57R+SP-57  DS-57S+SP-57
Sram Maven			 DS-67+SP-67  DS-67R+SP-67  DS-67S+SP-67















# MAGURA

Magura Louise 1999-2001, Clara-2000			 DS-04  DS-04R  DS-04S
Magura Julie 2001-2008, Lousie 2007			 DS-12+PIN-12  DS-12R+PIN-12  DS-12S+PIN-12
Magura Clara 2001 - 2002 , Louise 2002-2006 Louise FR 200, Promax DSK-903			 DS-14+PIN-12  DS-14R+PIN-12  DS-14S+PIN-12















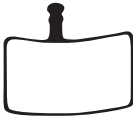









# MAGURA

Magura Gustav M-2010			 DS-18+SP-18  DS-18R+SP-18
Magura Marta, Marta SL-2008 Marta Gold, Clark Skeletal			 DS-19+SC0205  DS-19R+SC0205  DS-19S+SC0205
Magura Louise 2007-2008, Marta 2009 Louise Bat, Louise Carbon, Julie hp Brake Force One BFO Brake			 DS-36  DS-36R  DS-36S
Magura MT( 2 / 4 / 6 / 8)			 DS-53  DS-53R  DS-53S
Magura MT5			 DS-61  DS-61R  DS-61S
Magura MT7 / MT5			 DS-62  DS-62R  DS-62S
Magura MT A2			 DS-68  DS-68R
Magura Gustav Pro			 DS-69  DS-69R



























# HAYES

Hayes HFX Mag / Plus / XC / HD / 9 Carbon 9XC / 9HD / MX1, HFX-9 hydr.+mech.			 DS-01+SP-01  DS-01R+SP-01  DS-01S+SP-01
Hayes MX-2, MX-3, MX-4, MX-5, Sole CX pro(comp / exper), QUAD QHD-(4 / 5 / SP ) PROMAX DSK-810, UNIQUE mechanical			 DS-26  DS-26R  DS-26S
Hayes El Camino, EL trail Hydraulic			 DS-37+W/SP  DS-37R+W/SP  DS-37S+W/SP























# HAYES

Hayes Stroker Ryde, Dyno			 DS-40+SP-40  DS-40R+SP-40  DS-40S+SP-40
Hayes Stroker (Trail / Carbon / Gram)			 DS-41+W/SP  DS-41R+W/SP  DS-41S+W/SP
Hayes Stroker Ace			 DS-45+W/SP  DS-45R+W/SP  DS-45S+W/SP
Hayes Prime			 DS-49+SP-49  DS-49R+SP-49  DS-49S+SP-49
Hayes Dominion A			 DS-66+SP-66  DS-66R+SP-66  DS-66S+SP-66





















# HOPE

Hope C2 / O2, Giant MPH 2000			 DS-05+PIN-05  DS-05R+PIN-05
Hope Mini			 DS-20+SP-20  DS-20R+SP-20  DS-20S+SP-20
Hope DH4, E4, M4			 DS-22+SP-22
Hope XC 4-Piston			 DS-24+SP-24  DS-24R+SP-24  DS-24S+SP-24
Hope Mono 6 ti			 DS-28+SP-28  DS-28R+SP-28  DS-28S+SP-28
Hope Mono mini			 DS-29+SP-29  DS-29R+SP-29  DS-29S+SP-29

# HOPE

Hope moto V2			 DS-35+SP-35  DS-35R+SP-35  DS-35S+SP-35
Hope mono Trail, Trial Zone			 DS-39  DS-39R  DS-39S
Hope Tech V2, mini X2			 DS-48+SP-35  DS-48R+SP-35  DS-48S+SP-35
Hope V4 brake			 DS-58+SP-43  DS-58R+SP-43
Hope E4 brake			 DS-64+SP-09  DS-64R+SP-09

# FORMULA

Formula B4 (Extreme / Team / Pro Pro+ / SL / SL+) , 4 Racing XC Extreme (FR / DH&BR / Team / Pro SL)			 DS-16+SP-16  DS-16R+SP-16  DS-16S+SP-16
Formula ORO, K18, K24			 DS-31+SP-31  DS-31R+SP-31  DS-31S+SP-31
Formula Mega, RO Racing, T1 Racing R1 Racing, The one, R1, FR, RX, RO, T 1, C1, CR3, RR1			 DS-42+SP-42  DS-42R+SP-42  DS-42S+SP-42
Formula Cura 4			 DS-65+SP-65  DS-65R+SP-65  DS-65S+SP-65

# TEKTRO

Tektro (Aquila / IO) Novela-2010 hydraulic, mechanical			 DS-08  DS-08R  DS-08S
--	---	--	---

## TEKTRO

Tektro Lyra IOX, Novela



- DS-46
- DS-46R
- DS-46S

Tektro Dorado HD-E710



- DS-59+SP-59
- DS-59R+SP-59

## GIANT

Giant MPH 2001-2005



- DS-21
- DS-21R
- DS-21S

## PROMAX

A+B : Promax DSK-(200 / 200S / 400 / 400E / 400S / 610) mechanical  
B+B : DSK-320 / 700 mechanical

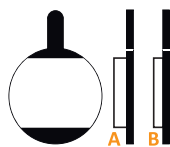

- DS-30
- DS-30R

## RST

Rst mechanical



- DS-06
- DS-06R

## CANNONDALE

Cannondale Coda Caliper



- DS-03
- DS-03R

## ALHONGA

Alhonga SNG Mechanical Disc Brake 200M  
Zoom DB-250 / 350 / 450 / 550



- DS-23
- DS-23R

## LOGAN

Logan DX 2001 / 2002



- DS-25
- DS-25R

## SUNTOUR

SR SUNTOUR DB XCC-MC Mechanical,  
Tektro SUB, e-sub, Twin, Volans, TRP  
Parabox 2011 Rear



- DS-27+SP-27
- DS-27R+SP-27

## DIATECH

Dia-tech Anchor / Armor  
Promax DSK-901



- DS-32
- DS-32R



E-bike compound is specially adapted to the requirements of e-bikes. It offers powerful, stable braking power, excellent wear resistance and longer lifespan.

SHIMANO



 **DS-10E+SP-10**



 **DS-17E+SP-17**



 **DS-43E+SP-43**



 **DS-53E**



 **DS-61E**



 **DS-44E+SP-44**



 **DS-54E+SP-54**



 **DS-57E+SP-57**



 **DS-62E**



 **DS-42E+SP-42**

AVID

MAGURA

FORMULA



**C55D**

- Lighter, more exclusive and more premium brake set with a beautiful finish in White/Gold, Black/Gold, Pink/Blue
- CNC machined brake holders Compatible with all major V-BRAKE
- Length : 72mm



**472C**

- Shimano, TRP and all major road brake system compatible
- Full CNC machined extra-light holder
- High-friction coefficient compound



**500C**

- Lightweight cartridge type brake
- Triple contour design



**460CL**

- Campagnolo compatible-2011
- Extra-light holder with fixing spring
- High-friction coefficient compound



**C56D**

- Lighter, more exclusive and more premium brake set with a beautiful finish in White/Gold, Black/Blue, Pink/Blue
- CNC machined brake holders
- Compatible with all major Road Brake



**MTB-971VC**

- Extra-light V-brake shoes design
- High braking coefficient rubber compound



### MTB-945V

- Length : 72mm



### MTB-945VC

- Cartridge brake shoes set
- Aluminum-Pad Holder
- Finish : Silver, Black



### MTB-945VCR

- Replacement of MTB-945VC
- Pads & pins only
- Length : 72mm



### MTB-955VC

- Cartridge brake shoes set
- Aluminum-Pad Holder
- Available for triple-color pad
- Finish : Silver, black



### MTB-955VC-2

- Cartridge brake shoes set
- Aluminum-Pad Holder
- Available for triple-color pad



### MTB-955VCR

- Replacement of MTB-955VC
- Available for triple-color pad
- Pads & Pins only
- Length : 72mm



### MTB-959V

- V-brake pads
- New aqua-guide design
- Length : 72mm



### MTB-959VC

- All weather compound
- New groove design



### MTB-959VCR

- Replacement of MTB-959VC
- Pad & pins only
- Length : 72mm



### MTB-960V

- V-brake pads
- Triple contour design
- Length : 72mm



### MTB-470CV

- Triple-contour road brake pad
- Suitable for folding bike
- Length : 55mm



### MTB-453CV

- Suitable for folding bike
- Length : 55mm



**MTB-935V**

- Length : 55mm



**MTB-943V**

- Length : 65mm



**MTB-946V**

- Length : 70mm



**MTB-947V**

- Available for two-tone color
- Color options : Red / Yellow
- Length : 70mm



**MTB-948V**

- Length : 60mm



**MTB-948D**

- Black Threaded Type
- Transparent & Blue / Red Brake
- Block For Alloy Rims
- Length : 60 mm



**MTB-470V**

- Triple-contour design
- Length : 55mm



**MTB-957V**

- Length : 70mm



**MTB-961VC**

- Cartridge brake shoes set
- Aluminum-Pad Holder
- Length : 72mm



**IKO-401.12**

- Corratex Bow design
- Length : 76mm



### 453-2

- For Alloy rim use
- Compatible with Shimano direct mount type brake
- Replacement of 453C / 432C / 456C / 456CL  
459C / 472C / C56D / 453CV / 453D
- Length : 55mm



### 453D

- 2-piece Brake shoe set
- For Ultegra BR-6810 direct-mount caliper



### 432C

- EN standard compound
- Length : 55mm

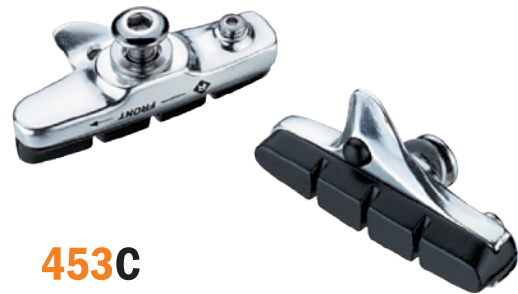

### 453C

- Compatible with Shimano / SRAM  
brake systems
- Length : 55mm



### 456CL

- Ultra light holder design
- Angle adjustable designed
- Length : 55mm



### 456C

- Cartridge brake shoes set
- Aluminum-Pad Holder
- Angle adjustable designed
- Length : 55mm



### 457C

- Cartridge brake shoes set
- Aluminum-Pad Holder
- Ditch way design for wet condition
- Length : 55mm



### 457

- Ditch way design for wet condition
- Replacement of 457C
- Length : 55mm



### 459C

- Cartridge brake shoes set
- Aluminum-Pad Holder
- Compatible with Shimano 105 SC  
Ultegra& Dura-Ace
- Length : 55mm



**460-2**

- For Alloy rim use
- Compatible with Campagnolo system (spring hole type)
- Length : 55mm



**460C**

- Cartridge brake shoes set
- Aluminum-Pad Holder
- Compatible with Campagnolo Record 10, Chorus 10, Center 10
- Length : 55mm



**467CLA**

- Cartridge brake shoes set
- Aluminum-Pad Holder
- Stable brake performance
- Length : 55mm



**467**

- For Alloy rim
- Compatible with Shimano and all major brake system
- Superior heat dissipation
- Replacement of 467CLA

## 5-in-1 Brake Shoes



**476 (Alloy Rim)**

**476-AP (Carbon Rim)**

- Various compounds are available for carbon rims or alloy rims
- Low - profile design for wider rim (23mm and up) use
- Compatible with 5 types of cartridges as shown below



**476C**

- Shimano Standard Mount Brake
- Cartridge brake shoes set
- For Alloy rim use
- Length : 55mm



**476D**

- Shimano DIRECT Mount Brake
- Cartridge brake shoes set
- For Alloy rim use
- Length : 55mm



	Standard	Direct Mount	Universal
Shimano			
Campagnolo			



### 468SC

- Compatible with Shimano and all major road brake system
- For Alloy Rim
- Crud Clean & Water Remove function
- Anti-Squeal design



### 468CC

- Compatible with campy (Up To Speed 11)
- For Alloy Rim
- Crud Clean & Water Remove function
- Anti-Squeal design



### 468

- Compatible with both Shimano & Campy brake
- For Alloy Rim
- Crud Clean & Water Remove function
- Anti-Squeal design
- Length: 55mm



### 461C

- Cartridge road brake shoes set
- Aluminum pad holder
- Compatible with Shimano 105 SC, Ultegra& Dura-Ace
- Triple-color pad



### 461

- Replacement of 461C
- Triple-color pad
- Length : 55mm



### 470TC

- Triple-contour road brake pad
- Compatible with all major road brake
- Extra-light holder
- Triple-color



### 470TCR

- Replacement of 470TC / 470CV
- Length : 55mm



### 471C

- Extra light road brake set
- Compatible with all major road brake
- Cartridge available in Black / Red / Ti / Orange



### 471TCR

- Replacement of 471C
- Length : 55mm



**MTB-950**

- Trial Pad for Magura Hydraulic Brake
- Length : 50mm

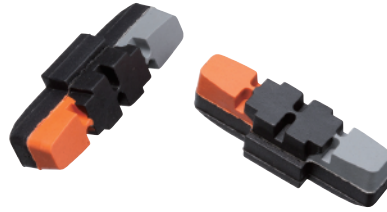

**MTB-950T**

- Trial Pad for Magura Hydraulic Brake
- Length : 50mm



**450**

- Length : 50mm



**451**

- Length : 50mm



**452**

- Length : 50mm



**458**

- Angle adjustable
- Length : 55mm

## CANTILEVER BRAKE SHOES

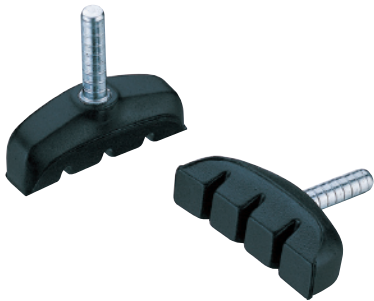

**MTB-931**

- Length : 53mm



**MTB-934**

- Length : 60mm



**MTB-935**

- Length : 55mm



**MTB-936**

- Length : 65mm



**MTB-937**

- Length : 60mm



**MTB-938**

- Length : 65mm



### MTB-939

- Hardened aluminum post
- Length : 64mm



### MTB-939U

- Threaded type
- Length : 64mm

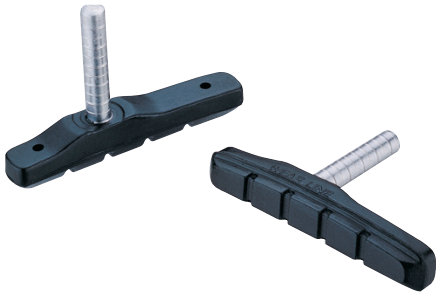

### MTB-945

- Hardened steel post
- Length : 72mm



### MTB-945VCP

- Cartridge brake shoes set
- Aluminum-Pad Holder
- Length : 72mm

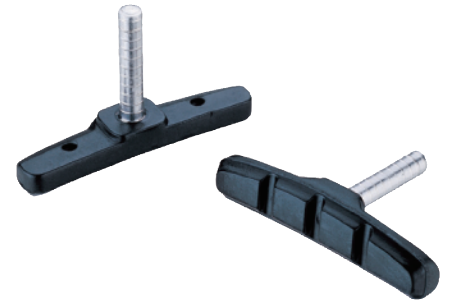

### MTB-947

- Hardened steel post
- Available for two-tone color
- Length : 70mm

## CALIPER BRAKE SHOES



### IKO-401.11

- Corratec Bow design
- Hardened aluminum post
- Length : 76mm
- Color options : Red / Yellow / Gray



### 203S

- Length : 35mm

### 203M

- Length : 40mm



### 203MW

- Taper : 8 °
- Embedded Leather Strip
- Length : 40 mm



### 206S

- Length : 35mm

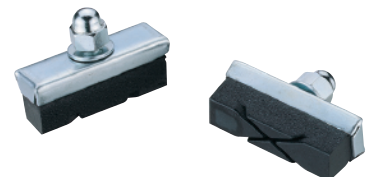

### 207

- X pattern
- Length : 40mm

- Avoid pitching over
- More braking control
- Shorten braking distance
- Suspension feeling

# ABS TECH ANTI-LOCK BRAKE SYSTEM

## ABS-01RC

- 2-piece Road brake shoe
- Length : 55mm



## ABS-01RCR

- Replacement of ABS-01RC
- Length : 55mm



## ABS-01VC

- 2-piece V-brake shoe set
- Length : 72mm



## ABS-01VCR

- Replacement of ABS-01VC
- Length : 72mm



## ABS-02V

- One-piece ABS-function V-brake shoes
- Length : 72mm

## BMX

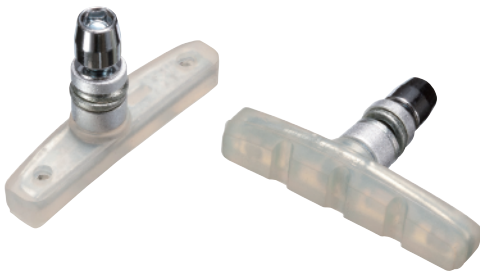

## MTB-948V Clear

- Clear compound for Trial bikes V-type brake shoes
- Color options : shown as below
- Length : 60mm



## MTB-960V Clear

- Clear compound for Trial bikes V-type brake shoes
- Color options : shown as below
- Length : 72mm



## MTB-950 Clear

- Clear compound for Trial bikes
- Fit Magura hydraulic rim brake
- Length : 55mm

# COOLING SOLUTION

## CARBON COMPOUND

This is an outstanding compound that gives excellent performance on all carbon rims, giving market leading performance in both dry/wet conditions. As such this is Baradine's NO1 selling compound and is universally considered as the ideal all round performance that allows users to brake with assertiveness that only comes from knowing your riding the best, which is why its also selected by all after market brands which Baradine supply.

## CERAMIC COMPOUND

If you ride ceramic rims then the only compound you'll want to use is Baradine.

Baradine has develop a range of super sticky compounds specifically for trails use where you needs huge amounts of stopping power instantaneously, for this compound pad wear / noise take fourth place for the characteristics profile following performance, performance and performance.



### 467CLC

- Cartridge brake shoes set
- Aluminum-Pad Holder
- Finish : Silver, black, anodized
- Length : 55mm



### 467KA

- For carbon rim
- Compatible with Shimano and all major brake system
- Superior heat dissipation
- Stable brake performance
- Replacement of 467CLC
- Length : 55mm

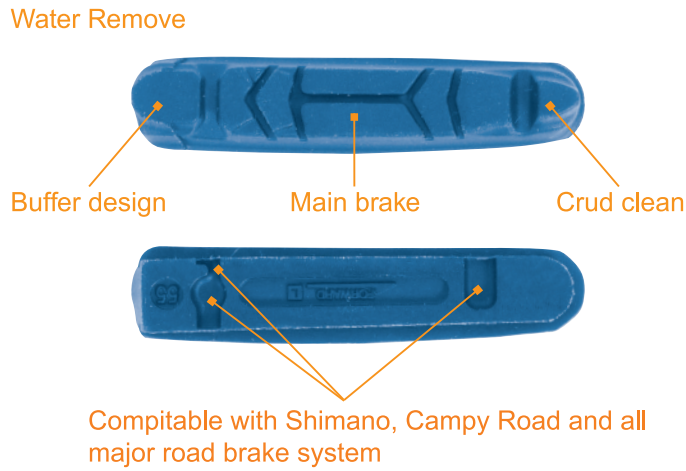

### 468-PRO

- For Carbon rim
- All weather compound
- Anti-Squeal design
- Replacement of 468SC / 468CC
- Length : 55mm



### 468CC

- Compatible with CAMPY brake (Up to 11 speed)
- For Carbon rim
- All weather compound
- Crud Clean & Water Remove function
- Anti-Squeal design
- Length : 55mm



### 468-PRO

- Compatible with Shimano brake
- For Carbon rim
- All weather compound
- Crud Clean & Water Remove function
- Anti-Squeal design
- Length : 55mm

## PRO COMPOUND

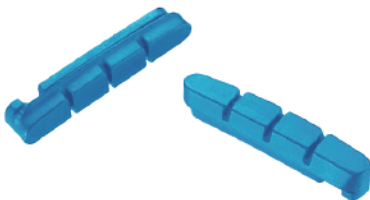

### 453-2-PRO

- For Carbon rim use only
- Compatible with Shimano direct mount type brake
- Replacement of 453C
- Length : 55mm

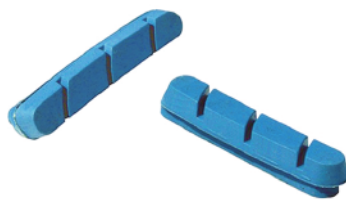

### 460-2-PRO

- For Carbon rim use only
- Compatible with Campagnolo system (spring hole type)
- Replacement of 460C
- Length : 55mm



### 959VCR-PRO

- For Carbon rim use only
- Compatible with V-brake
- Replacement of 959VC
- Length : 72mm



### 453-2-CORK

- Compatible with Shimano 105 SC, Ultegra & Dura-Ace
- Use with carbon rims only
- Replacement of 453C



### 460-2-CORK

- Compatible with Campagnolo Record, Chorus, Centaur&Veloce 2000
- Use with carbon rims only
- Replacement of 460C

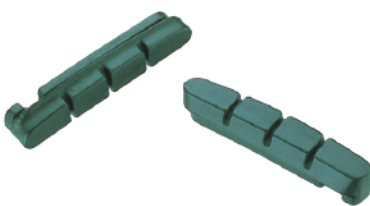

### 453-2-CE

- Compatible with Shimano 105 SC, Ultegra & Dura-Ace
- Use with carbon ceramic only
- Replacement of 453C

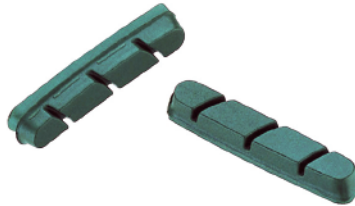

### 460-2-CE

- Compatible with Campagnolo Record 10, Chorus 10, Centaur 10
- Use with ceramic rims only
- Replacement of 460C

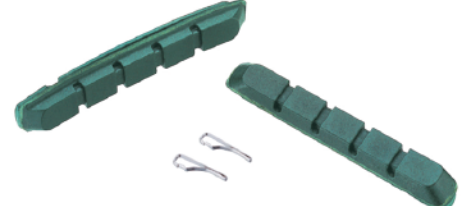

### MTB-945VCR-CE

- Use with ceramic rims only
- Replacement of 945VC
- Pads & pins only
- Legth :72mm



### 473CL

- Shimano, TRP and all major road brake systems compatible
- Extra braking-surface for better braking performance and heat dissipation
- Extra-light brake shoe holder design
- High braking coefficient compound
- For carbon rim use



### 474CL

- Campagnolo brake systems compatible
- Extra braking-surface for better braking performance and heat dissipation
- Extra-light brake shoe holder design
- High braking coefficient compound
- For carbon rim use













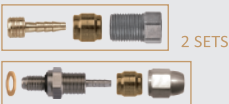

### 473

- Replacement of 473CL

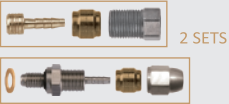

### 474

- Replacement of 474CL

Part No.	Material	Compatible Systems	End Fittings
<b>AVID</b>			
			
BH-101	KEVLAR + NYLON	XX World Cup 2010-2011 XX 2010-2011 Juicy Ultimate / Juicy Carbon Juicy Seven/ Juicy Five	<b>HP-A-01</b>  2 SETS
BH-111	KEVLAR + YARN		
BH-121	KEVLAR + STAINLESS		
BH-102	KEVLAR + NYLON	Juicy 3 / Elixir 1 / 3 CODE 2008-2010 / 5 / 7 / R2011 DB 2016 / 1 / 3	<b>HP-A-02</b>  4 SETS
BH-112	KEVLAR + YARN		
BH-122	KEVLAR + STAINLESS		
BH-103	KEVLAR + NYLON	Elixir R / 7 Trail / 9 Trail CR / CR Mag / 5 / 7 / 9 X0 / X0 Trail XX2012+ XX World Cup 2012	<b>HP-A-03</b>  2 SETS
BH-113	KEVLAR + YARN		
BH-123	KEVLAR + STAINLESS		
BH-104	KEVLAR + NYLON	Guide Ultimate / RS & R (2017) Guide RSC (2017) / RE (2017) Code RSC & R (2018) / TLM & TL RED HRD / Force HRD / Rival HRD Apex HRD S-700 / Level Ultimate	<b>HP-A-04</b>  4 SETS
BH-114	KEVLAR + YARN		
BH-124	KEVLAR + STAINLESS		
<b>SHIMANO</b>			
			
BH-201	KEVLAR + NYLON	XTR M975 / SLX M665 / DeoreLX T665 / XT M775 / Hone M601 Alfne S500 / S501 / Metrea U5000 Alivio M4050 / Acrea M3050 Non-Series T605 / MT500 / M575 M486 / M485 / M446 / M445	<b>HP-S-01</b>  4 SETS
BH-211	KEVLAR + YARN		
BH-221	KEVLAR + STAINLESS		
BH-202	KEVLAR + NYLON	XTR 2005-2006	<b>HP-S-02</b>  4 SETS
BH-212	KEVLAR + YARN		
BH-222	KEVLAR + STAINLESS		
BH-203	KEVLAR + NYLON	DEORE XT 2005-2007	<b>HP-S-03</b>  2 SETS
BH-213	KEVLAR + YARN		
BH-223	KEVLAR + STAINLESS		
BH-204	KEVLAR + NYLON		XTR M9120 / M9100 / M9020 Saint M820 / Deore XT M8120 M8100 / M8020 / M8000 SLX M7120 / M7100 Zee M640 / Deore M6000
BH-214	KEVLAR + YARN		
BH-224	KEVLAR + STAINLESS		
<b>MAGURA</b>			
			
BH-301	KEVLAR + NYLON	Clara 2000-2002 / Gustav M2011 Julie HP 2009 / Marta 2002-2010 Marta SL2003-2011 / Gold 2007 Louise 2000-2010 / FR 2002-2006 Louise BAT 2008-2010 Louies Carbon 2008-2010	<b>HP-M-01</b>  2 SETS
BH-311	KEVLAR + YARN		
BH-321	KEVLAR + STAINLESS		
BH-302	KEVLAR + NYLON	Gustav M 2000-2010 Marta 2007-2010 / Gold 2007 Marta SL 2008-2010 / MT Trail MT8 / MT7 / MT6 / MT5	<b>HP-M-02</b>  2 SETS
BH-312	KEVLAR + YARN		
BH-322	KEVLAR + STAINLESS		
<b>FORMULA</b>			
			
BH-401	KEVLAR + NYLON	R1R / R1 / RO / RX / T1 / MEGA	<b>HP-F-01</b>  2 SETS
BH-411	KEVLAR + YARN		
BH-421	KEVLAR + STAINLESS		

Part No.	Material	Compatible Systems	End Fittings
<b>HAYES</b>			
BH-501	KEVLAR + NYLON	Prime Expert / Prime Pro Prime Comp / Sport Stroker Trail / Carbon Stroker Ace / Gram / Ryde Dyno Sport / Comp / Radar	<p><b>HP-H-01</b> 4 SETS</p>
BH-511	KEVLAR + YARN		
BH-521	KEVLAR + STAINLESS		
<b>TEKTRO</b>			
BH-601	KEVLAR + NYLON	HD-M535 / HD-M530 HD-T535 / HD-T532 HD-T281 / HD-T280 HD-R286 / HD-R285	<p><b>HP-T-01</b> 4 SETS</p>
BH-611	KEVLAR + YARN		
BH-621	KEVLAR + STAINLESS		
<b>TEKTRO</b>			
BH-602	KEVLAR + NYLON	HD-E745 / HD-E740 HD-E545 / HD-E540 HD-T745 / HD-T740 / HD-T737 HD-T545 / HD-T540	<p><b>HP-T-02</b> 4 SETS</p>
BH-612	KEVLAR + YARN		
BH-622	KEVLAR + STAINLESS		

## ACCESSORIES









	Item	Spec
	CAPBP 01	Plastic fits 5mm brake housing
	CAPDP 01	Plastic fits 4mm shift housing
	CAPBC 01	Copper pressed fits 5mm brake housing
	CAPDC 01	Copper pressed fits 4mm shift housing
	CAPBA 01	Aluminum CNC machined fits 5mm brake housing
	CAPDA 01	Aluminum CNC machined fits 4mm shift housing
	TIP 01	Aluminum CNC machined fits 1.2-1.5mm sinner wire
	RB-01	Nylok anit loosen treated T25 TROX - M5*10mm

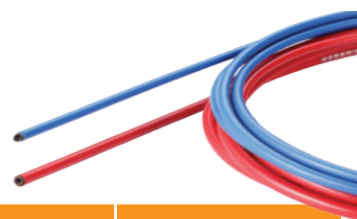

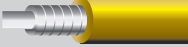
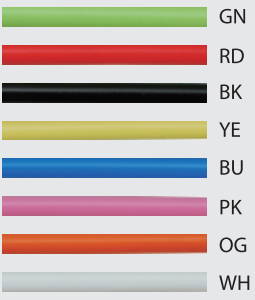
Specification	Use	Part No.			Package
		SHIMANO	CAMPAGNOLO	MTB UNIVERSAL	
TEFLON COATED SLICK TREATMENT	BRAKE 1.7M/PC	BI-S-TSC-01	BI-C-TSC-01	BI-M-TSC-01	1PC / HEADER CARD
		BI-S-TSC-02	BI-C-TSC-02	BI-M-TSC-02	50PC / BOX
		BI-S-TSC-03	BI-C-TSC-03	BI-M-TSC-03	100PC / BOX
	SHIFT 2.1M/PC	DI-S-TSC-01	DI-C-TSC-01		1PC / HEADER CARD
		DI-S-TSC-02	DI-C-TSC-02		50PC / BOX
		DI-S-TSC-03	DI-C-TSC-03		100PC / BOX
STAINLESS STEEL SLICK TREATMENT	BRAKE 1.7M/PC	BI-S-SS-01	BI-C-SS-01	BI-M-SS-01	1PC / HEADER CARD
		BI-S-SS-02	BI-C-SS-02	BI-M-SS-02	50PC / BOX
		BI-S-SS-03	BI-C-SS-03	BI-M-SS-03	100PC / BOX
	SHIFT 2.1M/PC	DI-S-SS-01	DI-C-SS-01		1PC / HEADER CARD
		DI-S-SS-02	DI-C-SS-02		50PC / BOX
		DI-S-SS-03	DI-C-SS-03		100PC / BOX
GALVANIZED STEEL SLICK TREATMENT	BRAKE 1.7M/PC	BI-S-SG-01	BI-C-SG-01	BI-M-SG-01	1PC / HEADER CARD
		BI-S-SG-02	BI-C-SG-02	BI-M-SG-02	50PC / BOX
		BI-S-SG-03	BI-C-SG-03	BI-M-SG-03	100PC / BOX
	SHIFT 2.1M/PC	DI-S-SG-01	DI-C-SG-01		1PC / HEADER CARD
		DI-S-SG-02	DI-C-SG-02		50PC / BOX
		DI-S-SG-03	DI-C-SG-03		100PC / BOX

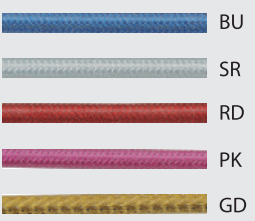

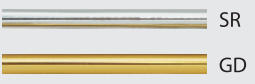

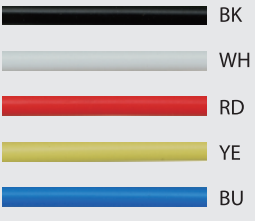
Material	Color	Specification	Part No.	Lenght	Package					
 <p>SD</p>		Standard 2P coiled brake housing	BH-SD-01	2.5M	HEADER CARD					
			BH-SD-02	7.5M	HEADER CARD					
			BH-SD-03	50M	WORKSHOP BOX					
		Standard SP linear shift housing			DH-SD-01	2.5M	HEADER CARD			
					DH-SD-02	7.5M	HEADER CARD			
					DH-SD-03	50M	WORKSHOP BOX			
					 <p>YN</p>		Yarn 2P coiled brake housing	BH-YN-01	2.5M	HEADER CARD
								BH-YN-02	7.5M	HEADER CARD
								BH-YN-03	50M	WORKSHOP BOX
Yarn SP linear shift housing			DH-YN-01	2.5M			HEADER CARD			
			DH-YN-02	7.5M			HEADER CARD			
			DH-YN-03	50M			WORKSHOP BOX			
 <p>LA</p>		Shiny 2P brake housing	BH-LA-01	2.5M	HEADER CARD					
			BH-LA-02	7.5M	HEADER CARD					
			BH-LA-03	50M	WORKSHOP BOX					
		Shiny 2P linear shift housing			DH-LA-01	2.5M	HEADER CARD			
					DH-LA-02	7.5M	HEADER CARD			
					DH-LA-03	50M	WORKSHOP BOX			
 <p>AL</p>		Alloy+steel linear SP brake housing Double kevlar reinforced Pre-greased 50% lighter than standard 2P	BH-AL-01	2.5M	HEADER CARD					
			BH-AL-02	7.5M	HEADER CARD					
			BH-AL-03	50M	WORKSHOP BOX					
		Alloy+steel linear SP brake housing Double kevlar reinforced Pre-greased 35% lighter than standard SP			DH-AL-01	2.5M	HEADER CARD			
					DH-AL-02	7.5M	HEADER CARD			
					DH-AL-03	50M	WORKSHOP BOX			



BRAKE



SHIFT





**Baradine Rubber Industrial Co., Ltd.**

Punei St.377, Changhua 50024, Taiwan

Tel : 886-4-7112650 Fax : 886-4-7120839

E-mail : [baradine@ms25.hinet.net](mailto:baradine@ms25.hinet.net)